



### 1. Features

- 3 channel LED controller
- Maximum load 360W (120W for each channel)
- PWM (Pulse Width Modulation)
- Controller can generate any colour with required intensity of common anode RGB LED.
- Can work with:
  -  - RGB LEDs or three single colour LEDs (eg. LED strips, tapes, tubes etc.)
  -  - low voltage bulbs (classical and halogen 12-24V)
- Maximum LED supply voltage 12-24V
- Maximum LED current 5A for each channel
- Operation voltage from the bus 10-24V.
- Maximum current consumption from the bus 26mA.
- For DIN rail mounting.
- Dimensions 90x58x36 mm (2 mod)
- Functionality of the device depends on the installed firmware.
- Schematic and PCB design can be downloaded from [hapcan.com](http://hapcan.com) site



### 2. Application version

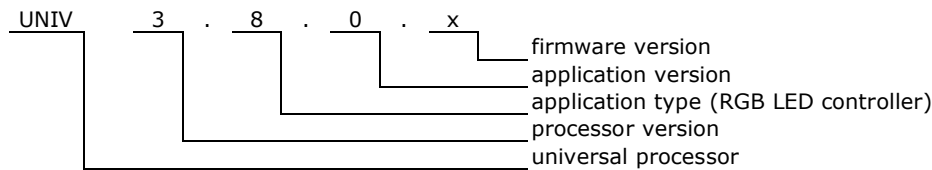

### 3. Technical data

#### Bus side

Parameter	Symbol	Value	Unit
Power supply voltage	$U_S$	10-24V	V
Maximum current consumption with all channels turn on	$I_{S_{MAX}}$	26	mA
Bus quiescent current	$I_{SQ}$	7	mA
Bus connector type	2x RJ45 connectors		

#### RGB LED side

Parameter	Symbol	Value	Unit
Power supply voltage	$U_N$	12-24V	V
Maximum LED current for one channel	$I_N$	5	A
Load Power for one channel	$S_N$	120 @24V	W
Voltage regulating range	$U_\phi$	0 - $U_N$	V
PWM frequency	f	488	Hz
Connector type	Terminal block 4mm <sup>2</sup>		

## 4. Hardware

### 4.1. Schematic

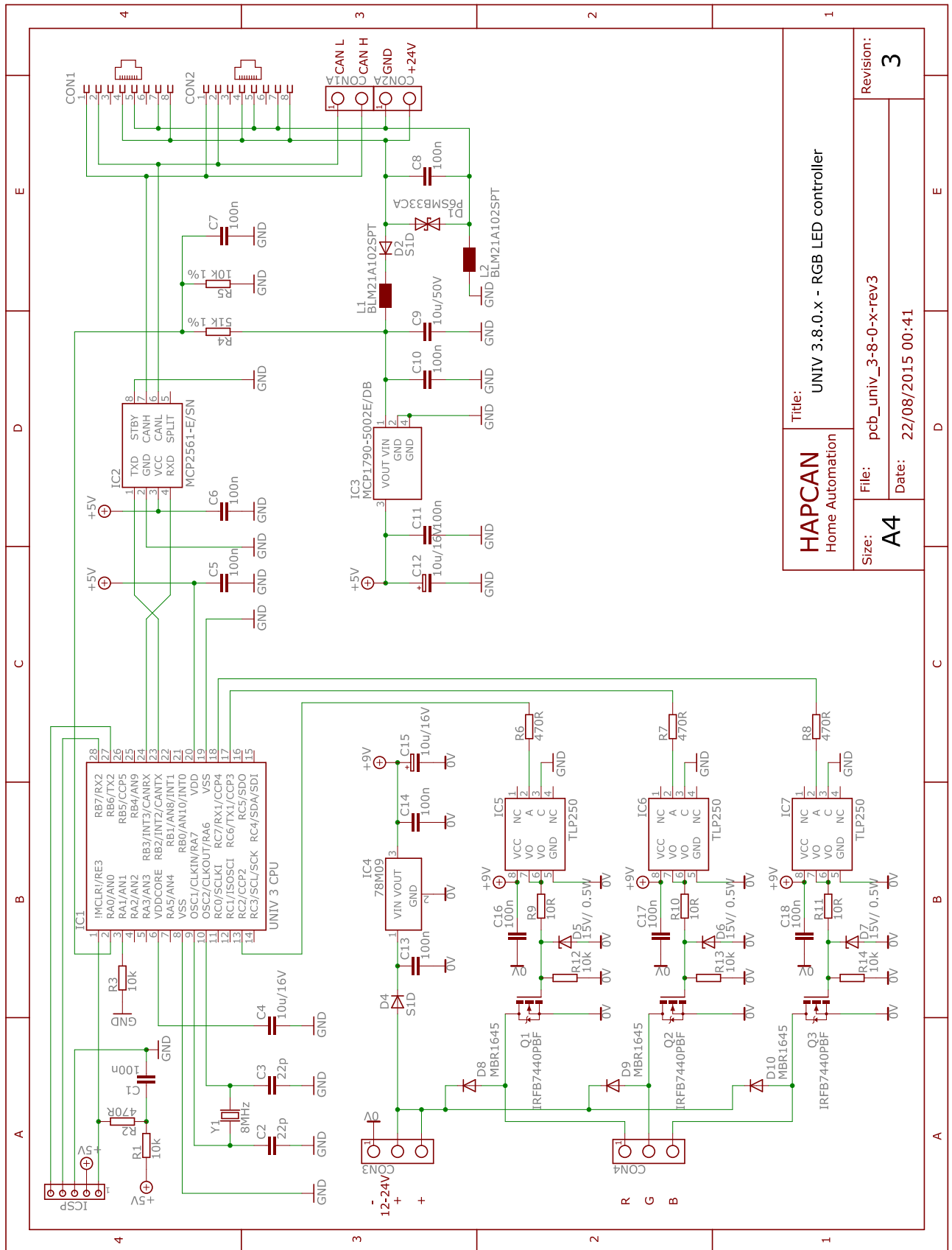

<b>HAPCAN</b> Home Automation		Title: UNIV 3.8.0.x - RGB LED controller	
Size: <b>A4</b>	File: pcb_univ_3-8-0-x-rev3	Revision: <b>3</b>	
	Date: 22/08/2015 00:41		

Figure 1. Schematic of UNIV 3.8.0.x module

**4.2. Wiring**

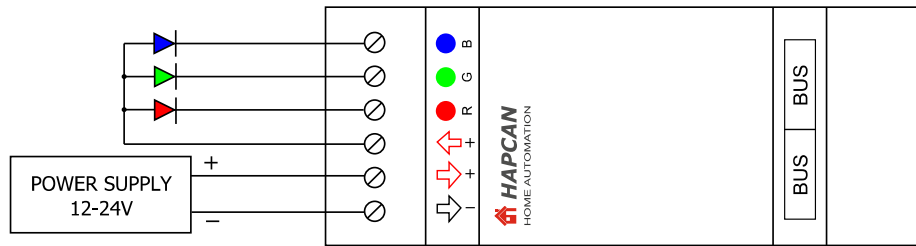
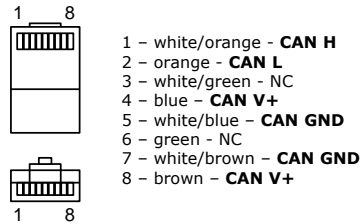

Figure 2. Wiring diagram



Note that if module is first or last on the bus, the terminator (resistor 120 Ohm) must be plugged into one of BUS ports.

Figure 3. RJ45 bus connector wiring.

**4.3. Assembly schematic**

- Printed circuit boards *PCB UNIV 3.8.0.x* for UNIV 3.8.0.x module
- PCBs dimensions: 86.5mm x 33mm

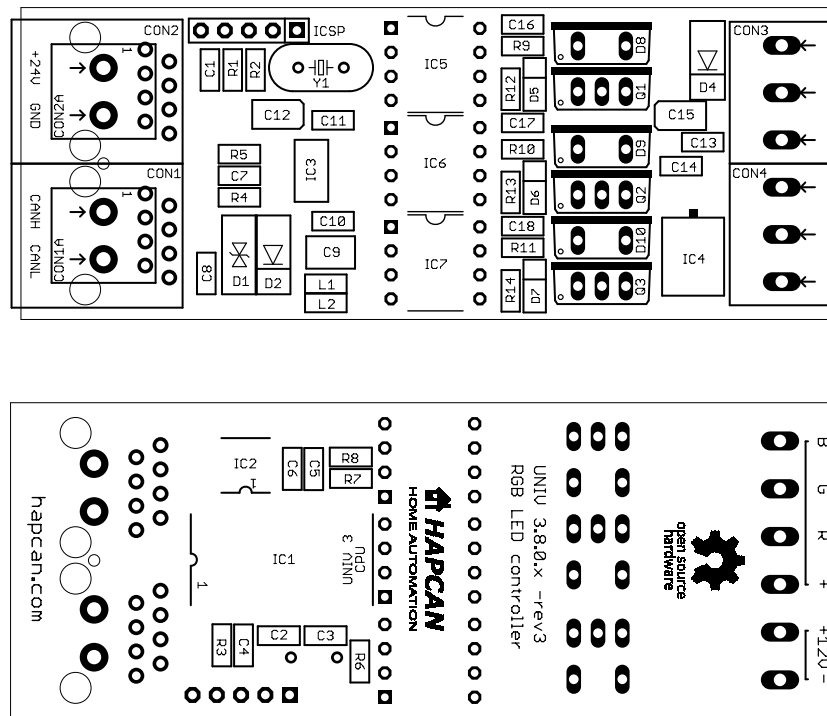

#### 4.4. Components

Designator	Type	Footprint	Description
C1, C5, C6, C7, C8, C10, C11, C13, C14, C16, C17, C18	100nF/50V ±10%	0805	Capacitor
C2, C3	22pF/50V ±10%	0805	Capacitor
C4	10uF/16V ±10%	0805	Capacitor
C9	10uF/50V ±10%	1206, 1210	Capacitor
C12, C15	10uF/16V ±10%	SMA, SMB	Tantalum capacitor
R1, R3, R12, R13, R14	10k	0805	Resistor
R2, R6, R7, R8	470 Ohm	0805	Resistor
R4	51k 1%	0805	Resistor
R5	10k 1%	0805	Resistor
R9, R10, R11	10 Ohm	0805	Resistor
L1, L2	BLM21A102SPT	0805	Murata choke
Y1	8MHz	HC49-S	Quartz crystal
D1	P6SMB33CA	DO-214	Transil diode
D2, D4	S1B	DO-214	Rectifying diode
D5, D6, D7	15V/ 0.5W	MINIMELF	Zener diode
D8, D9, D10	MBR1645	TO-220	Rectifying diode
IC1	UNIV 3 CPU	SOIC-28	HAPCAN universal processor
IC2	MCP2561-E/SN	SOIC-8	Microchip CAN transceiver
IC3	MCP1790-5002EDB	SOT-223	Microchip Voltage regulator
IC4	78M09	D-PAK	Voltage regulator
IC5, IC6, IC7	TLP250	DIP-8	Toshiba MOSFET driver
Q1, Q2, Q3	IRFB7440PBF	TO-220	International Rectifier MOSFET transistor
CON1, CON2	95501-2881	L18xW15xH11	Molex RJ45 connector
CON3, CON4	AK700/3-5.0-V-GREEN-BR	L15xW10.5xH19 raster=5mm	PTR Messtechnik Terminal block

#### 4.5. Enclosure

- Gainta D2MG enclosure (2 modules wide)
- Dimensions: 90mm x 58mm x 36mm

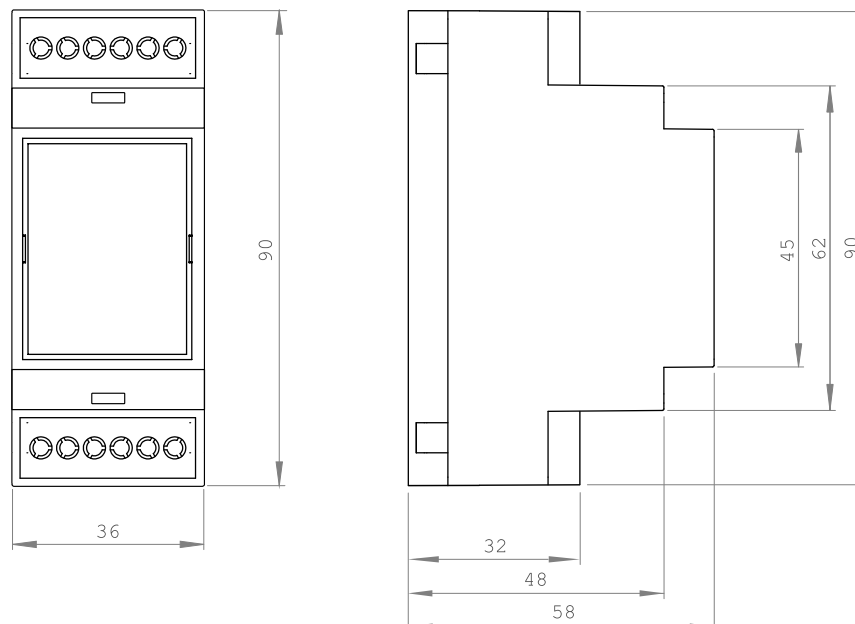

**4.6. Mechanical processing**

Striped parts must be removed.

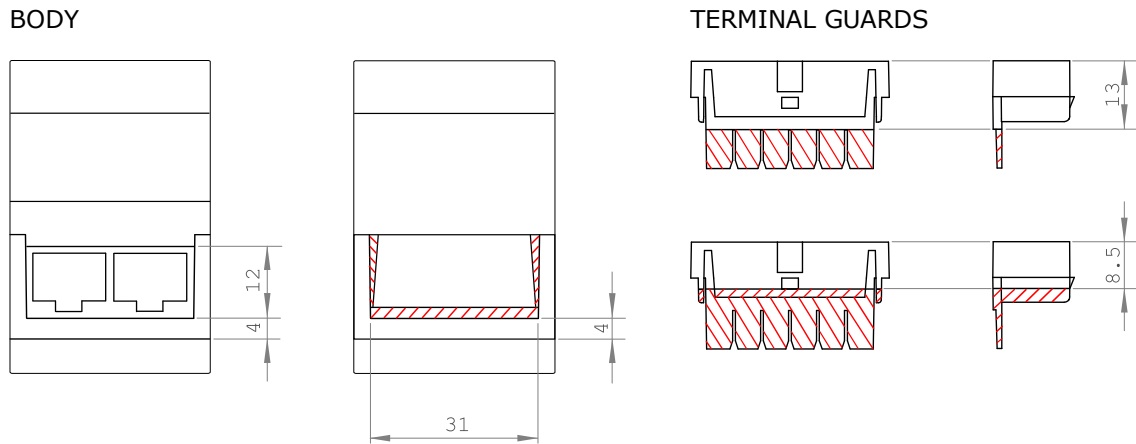

**4.7. Labels**

Editable labels version is available on [hapcan.com](http://hapcan.com) site.

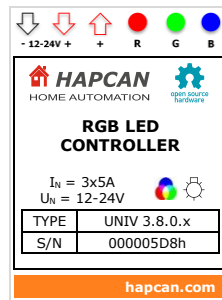

**5. Commissioning**

**5.1. CPU voltage measurement**

After verifying the correctness and quality of the soldering, the bus voltage should be connected while measuring the processor voltage. To do this, connect a voltmeter to pins 2 and 3 of the ICSP connector. Processor supply voltage should be about 5V.

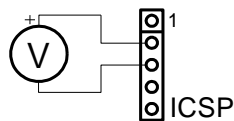

Figure 3. CPU voltage measurement

**5.2. Checking the CPU clock**

Proper operation of the CPU can be checked by temporarily connecting the LED to pins 3 and 5 of the ICSP connector. When device is powered, the LED should light up four times in the sequence 1 second on - 1 second off - 1 second on. The LED lights up only once for 50ms, if the processor is in programming mode.

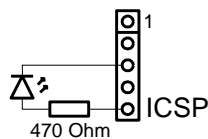

Figure 4. Checking the CPU clock

**5.3. Firmware uploading**

The device requires a firmware uploading for proper operation. It can be done with HAPCAN Programmer software. Both, firmware and HAPCAN Programmer can be downloaded from [hapcan.com](http://hapcan.com) website.

## 6. License



HAPCAN Home Automation Project hardware, Copyright (C) 2015 [hapcan.com](http://hapcan.com)

This device is free hardware: you can redistribute it and/or modify it under the terms of the GNU General Public License as published by the Free Software Foundation, either version 3 of the License, or (at your option) any later version.

This hardware is distributed in the hope that it will be useful, but WITHOUT ANY WARRANTY; without even the implied warranty of MERCHANTABILITY or FITNESS FOR A PARTICULAR PURPOSE. See the GNU General Public License for more details.

You should have received a copy of the GNU General Public License along with this documentation. If not, see <http://www.gnu.org/licenses/gpl-3.0.html>.

## 7. Document version

File	Hardware Revision	Description	Date
univ_3-8-0-x_a.pdf	rev1	Original version	January 2014
univ_3-8-0-x_b.pdf	rev1	Enclosure changed	February 2014
univ_3-8-0-x_c.pdf	rev2	Hardware revision 2	February 2015
univ_3-8-0-x_d.pdf	rev3	Hardware revision 3	August 2015