

**Ultra-slim 1 Pole - 6 A relay**  
**Printed circuit mount**  
- direct or via PCB socket  
**35 mm rail mount**  
- via screw, screwless or push-in terminal sockets

- 1 Pole changeover contacts or 1 Pole normally open contact
- Ultra slim, 5 mm, package
- Sensitive DC coil - 170 mW (Dual AC/DC coil drive possible using 93 series sockets)
- UL Listing (certain relay/socket combinations)
- Cadmium Free contact materials
- 8/8 mm clearance/creepage distance
- 6 kV (1.2/50  $\mu$ s) insulation, coil-contacts

FOR UL RATINGS SEE:  
"General technical information" page V

For outline drawing see page 5

**Contact specification**

Contact configuration		1 CO (SPDT)	1 CO (SPDT)
Rated current/ Maximum peak current	A	6/10	6/10
Rated voltage/ Maximum switching voltage	V AC	250/400	250/400
Rated load AC1	VA	1500	1500
Rated load AC15 (230 V AC)	VA	300	300
Single phase motor rating (230 V AC)	kW	0.185	0.185
Breaking capacity DC1: 30/110/220 V	A	6/0.2/0.12	6/0.2/0.12
Minimum switching load	mW (V/mA)	500 (12/10)	50 (5/2)
Standard contact material		AgNi	AgNi + Au

**Coil specification**

Nominal voltage ( $U_N$ )	V AC (50/60 Hz)	—	—
	V DC	5 - 12 - 24 - 48 - 60	5 - 12 - 24 - 48 - 60
Rated power AC/DC	VA (50 Hz)/W	—/0.17	—/0.17
Operating range	AC	—	—
	DC	(0.7...1.5) $U_N$	(0.7...1.5) $U_N$
Holding voltage	AC/DC	—/0.4 $U_N$	—/0.4 $U_N$
Must drop-out voltage	AC/DC	—/0.05 $U_N$	—/0.05 $U_N$

**Technical data**

Mechanical life AC/DC	cycles	—/10 · 10 <sup>6</sup>	—/10 · 10 <sup>6</sup>
Electrical life at rated load AC1	cycles	60 · 10 <sup>3</sup>	60 · 10 <sup>3</sup>
Operate/release time	ms	5/3	5/3
Insulation between coil and contacts (1.2/50 $\mu$ s)	kV	6 (8mm)	6 (8mm)
Dielectric strength between open contacts	V AC	1000	1000
Ambient temperature range	°C	-40...+85	-40...+85
Environmental protection		RT II	RT II

**Approvals** (according to type)



**34.51**



- 5 mm wide
- Low coil power
- PCB or 93 series sockets

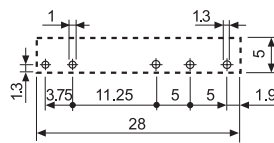
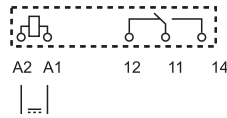

Copper side view

**NEW 34.51-5010**



- 5 mm wide
- Low coil power
- PCB or 93 series sockets
- Contact AgNi + Au

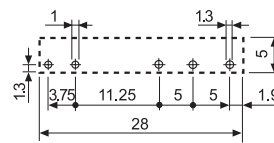
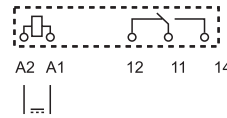

Copper side view

**Ultra-slim - Solid State Relays**

**Printed circuit mount**

- direct or via PCB socket

**35 mm rail mount**

- via screw, screwless or push-in terminal sockets

- Single circuit output switching options
  - 2 A, 24 V DC
  - 0.1 A, 48 V DC
  - 2 A, 240 V AC
- Silent, high speed switching with long electrical life
- Ultra slim, 5 mm, package
- Sensitive DC Input circuits (Dual AC/DC input drive possible using 93 series sockets)
- UL Listing (certain relay/socket combinations)
- Wash tight: RT III
- 2500 V insulation, input-output

**34.81-9024**



- 2 A, 24 V DC output switching
- PCB or 93 series sockets

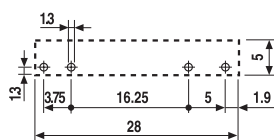
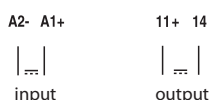

Copper side view

**34.81-7048**



- 0.1 A, 48 V DC output switching
- PCB or 93 series sockets

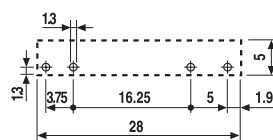
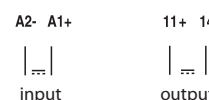
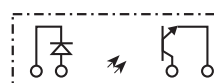

Copper side view

**34.81-8240**



- 2 A, 240 V AC output switching
- Zero crossing switching
- PCB or 93 series sockets

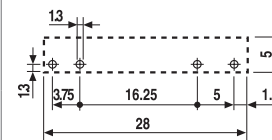
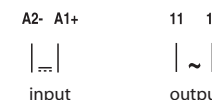

Copper side view

For outline drawing see page 5

**Output circuit**

Contact configuration	1 NO (SPST-NO)				1 NO (SPST-NO)		1 NO (SPST-NO)				
Rated current/ Maximum peak current (10 ms)	A	2/20				0.1/0.5		2/40			
Rated voltage/ Maximum blocking voltage	V	(24/33)DC				(48/60)DC		(240/—)AC			
Switching voltage range	V	(1.5...24)DC				(1.5...48)DC		(12...275)AC			
Repetitive peak off-state voltage	V <sub>pk</sub>	—				—		600			
Minimum switching current	mA	1				0.05		22			
Max. "OFF-state" leakage current	mA	0.001				0.001		1.5			
Max. "ON-state" voltage drop	V	0.12				1		1.6			

**Input circuit**

Nominal voltage	V DC	5	12	24	60	24	60	5	12	24	60
Rated power AC/DC	W	0.035	0.087	0.17	0.18	0.17	0.18	0.060	0.087	0.17	0.18
Operating range	V DC	35...12	8...17	16...30	35...72	16...30	35...72	35...10	8...17	16...30	35...72
Control current	mA	7	7.2	7	3	7	3	12	7.2	7	3
Release voltage	V DC	1	4	10	20	10	20	1	4	10	20
Impedance	Ω	715	1940	3200	21300	3200	21300	416	1940	3200	21300

**Technical data**

Operate/release time	ms	0.1/0.6*				0.04/0.6*		12/12*			
Dielectric strength between input/output	V	2500				2500		2500			
Ambient temperature range	°C	-20...+60				-20...+60		-20...+60			
Environmental protection		RT III				RT III		RT III			

**Approvals** (according to type)



\* Note: all technical data relates to using the relay directly on PCB or PCB socket type 93.11.

If the relay is used with 35 mm rail socket type 93.51, refer to the technical data of 38 Series; if used with types 93.60, 93.61, 93.62, 93.63, 93.64, 93.65, 93.66, 93.67, 93.68 and 93.69, refer to the technical data of the MasterINTERFACE 39 Series.

**A**

## Ordering information

### Electromechanical relay (EMR)

Example: 34 series slim electromechanical relay, 1 CO (SPDT) 6 A contacts, 24 V sensitive DC coil.

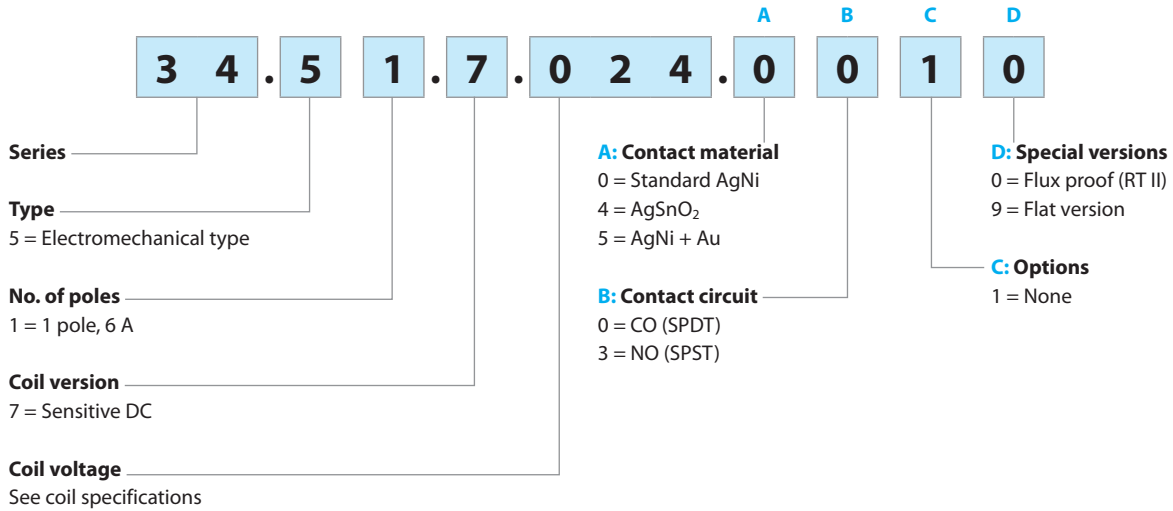

**Selecting features and options: only combinations in the same row are possible.**

Preferred selections for best availability are shown in **bold**.

Type	Coil version	A	B	C	D
34.51	sens. DC	<b>0</b> - 4 - 5	<b>0</b> - 3	<b>1</b>	<b>0</b>
34.51	sens. DC	0 - 4 - 5	0	1	9

### Solid state relay (SSR)

Example: 34 series SSR relay, 2 A output, 24 V DC supply.

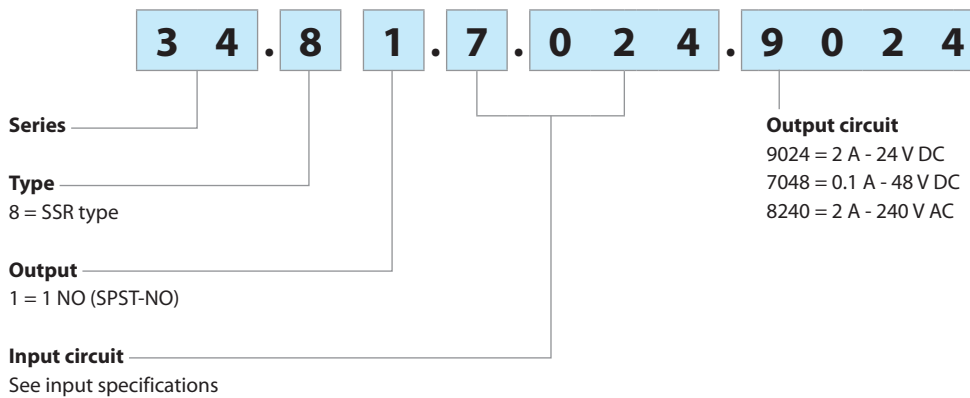

## Flat pack version

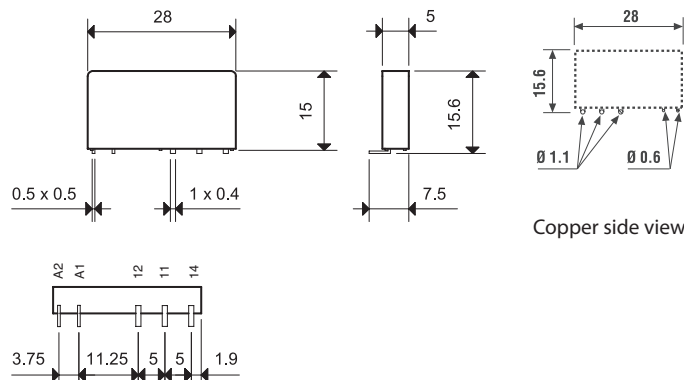
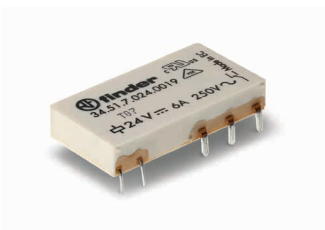

Option = 34.51.7xxx.x019

Environmental protection RT I

## Electromechanical relay

### Technical data

A

#### Insulation according to EN 61810-1

Nominal voltage of supply system	V AC	230/400	
Rated insulation voltage	V AC	250	400
Pollution degree		3	2

#### Insulation between coil and contact set

Type of insulation		Reinforced
Overvoltage category		III
Rated impulse voltage	kV (1.2/50 $\mu$ s)	6
Dielectric strength	V AC	4000

#### Insulation between open contacts

Type of disconnection		Micro-disconnection
Dielectric strength	V AC/kV (1.2/50 $\mu$ s)	1000/1.5

#### Conducted disturbance immunity

Burst (5...50)ns, 5 kHz, on A1 - A2	EN 61000-4-4	level 4 (4 kV)
Surge (1.2/50 $\mu$ s) on A1 - A2 (differential mode)	EN 61000-4-5	level 3 (2 kV)

#### Other data

Bounce time: NO/NC	ms	1/6	
Vibration resistance (5...55)Hz: NO/NC	g	10/5	
Shock resistance	g	20/14	
Power lost to the environment	without contact current	W	0.2
	with rated current	W	0.5
Recommended distance between relays mounted on PCB	mm	$\geq 5$	

### Contact specification

#### F 34 - Electrical life (AC) v contact current

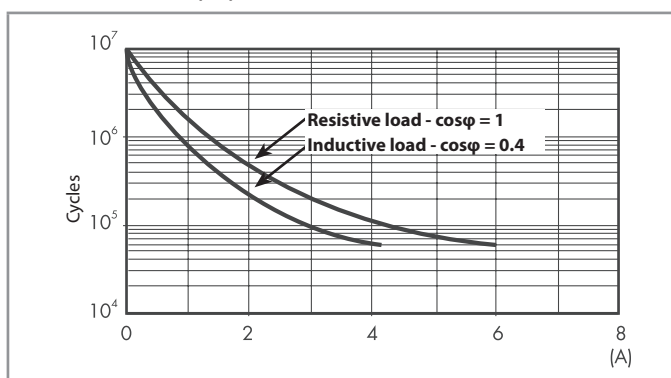

#### H 34 - Maximum DC1 breaking capacity

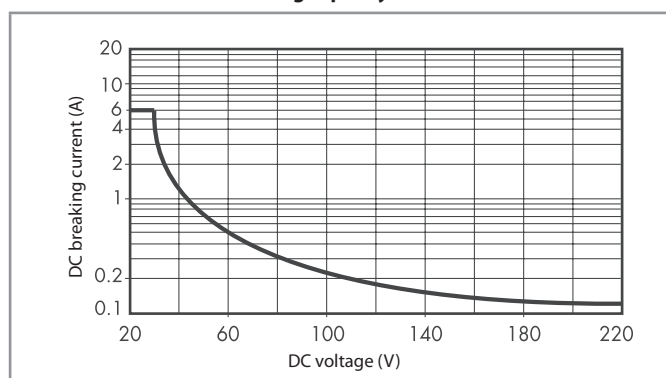

- When switching a resistive load (DC1) having voltage and current values under the curve, an electrical life of  $\geq 60 \cdot 10^3$  can be expected.
- In the case of DC13 loads, the connection of a diode in parallel with the load will permit a similar electrical life as for a DC1 load.  
Note: the release time for the load will be increased.

### Coil specifications

#### DC coil data

Nominal voltage $U_N$	Coil code	Operating range		Resistance $R$	Rated coil consumption $I$ at $U_N$
		$U_{min}$	$U_{max}$		
V		V	V	$\Omega$	mA
5	7.005	3.5	7.5	130	38.4
12	7.012	8.4	18	840	14.2
24	7.024	16.8	36	3350	7.1
48	7.048	33.6	72	12300	3.9
60	7.060	42	90	19700	3

#### R 34 - DC coil operating range v ambient temperature

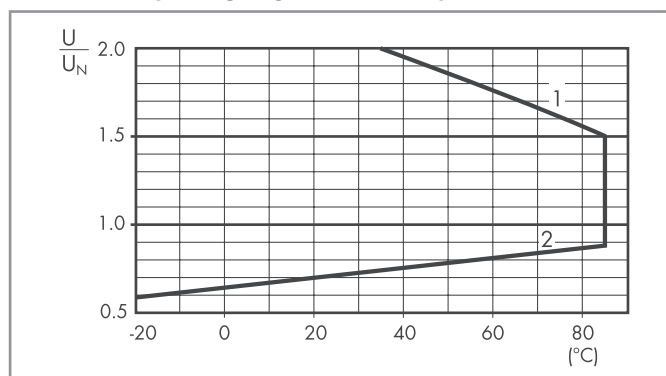

- 1 - Max. permitted coil voltage.
- 2 - Min. pick-up voltage with coil at ambient temperature.

## Solid state relay

A

### Technical data

EMC specifications		Reference standard	
Electrostatic discharge	contact discharge	EN 61000-4-2	4 kV
	air discharge	EN 61000-4-2	8 kV
Fast transients on supply terminals (burst 5/50 ns, 5 kHz)		EN 61000-4-4	2 kV
Voltage pulses on supply terminals (surge 1.2/50 $\mu$ s)	common mode	EN 61000-4-5	0.5 kV
	differential mode	EN 61000-4-5	0.5 kV
Other data			
Power lost to the environment	without output current	W	0.17
	with rated current	W	0.4

### Input specification

#### Input data - DC types

Nominal voltage $U_N$	Input code	Operating range		Release voltage	Impedance	Control current $I$ at $U_N$
		$U_{min}$	$U_{max}$			
V		V	V	V	$\Omega$	mA
5	7.005	3.5	12 (10*)	1	715 (416*)	7 (12*)
12	7.012	8	17	4	1940	7.2
24	7.024	16	30	10	3200	7
60	7.060	35	72	20	21300	3

\* AC Output version.

### Output specification

**L 34 - Output current v ambient temperature**  
SSR - 2 A DC & AC output types

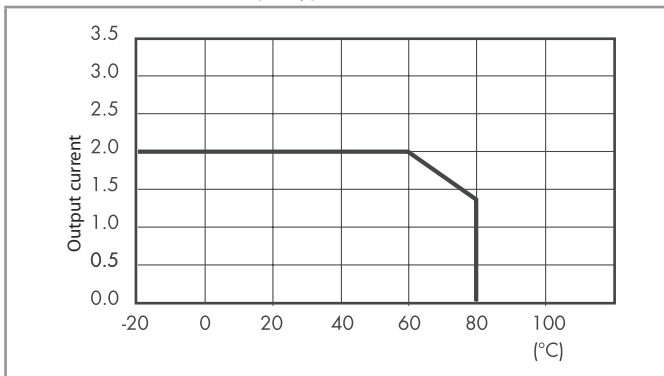

**L 34 - Output current v ambient temperature**  
SSR - 0.1 A DC output types

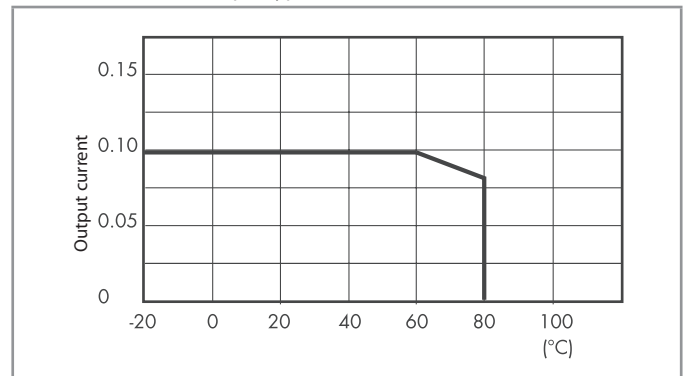

### Outline drawings

Type 34.51

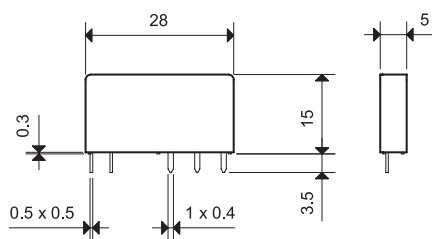

Type 34.81

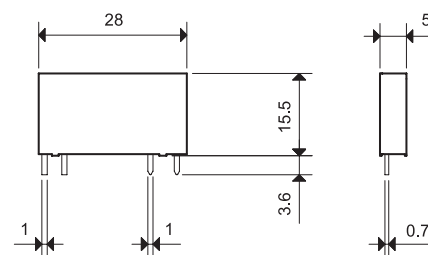

A



93.61

**Screw terminal socket** 35 mm rail mounting (EN 60715)

NEW

**Common features**

- Space saving 6.2 mm wide
- Connections for 16-way jumper link
- Integral coil indication and protection circuit
- Secure retention and easy ejection by plastic clip
- Dual screw head (blade+cross) terminals

For technical data and supply versions, refer to the Master **INTERFACE 39 Series** – “Relay interface module”

93.62

**Electromechanical Relay - EMR**

Supply voltage	Relay type	Socket type (reference with the 39 Series)				
		Master <b>BASIC</b> (39.11.....)	Master <b>PLUS</b> (39.31.....)	Master <b>INPUT</b> (39.41.....)	Master <b>OUTPUT</b> (39.21.....)	Master <b>TIMER</b> (39.81.....)
6 V AC/DC	34.51.7.005.xx10	93.61.7.024	93.63.7.024	93.64.7.024	93.62.7.024	—
12 V AC/DC	34.51.7.012.xx10	93.61.7.024	93.63.7.024	93.64.7.024	93.62.7.024	93.68.0.024
24 V AC/DC	34.51.7.024.xx10	93.61.7.024	93.63.7.024	93.64.7.024	93.62.7.024	93.68.0.024
60 V AC/DC	34.51.7.060.xx10	—	93.63.7.060	—	—	—
(110...125)V AC/DC*	34.51.7.060.xx10	—	93.63.3.125	—	—	—
(220...240)V AC*	34.51.7.060.xx10	—	93.63.3.230	—	—	—
(110...125)V AC/DC	34.51.7.060.xx10	93.61.0.125	93.63.0.125	93.64.0.125	93.62.0.125	—
(24...240)V AC/DC	34.51.7.024.xx10	—	93.63.0.240	—	—	—
(220...240)V AC	34.51.7.060.xx10	93.61.8.230	93.63.8.230	93.64.8.230	93.62.8.230	—
(110...125)V DC	34.51.7.060.xx10	—	93.63.7.125	—	—	—
220 V DC	34.51.7.060.xx10	—	93.63.7.220	—	—	—

\* Leakage current suppression

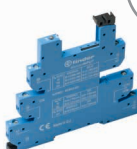

93.63

**Solid State Relay - SSR**

93.64

Supply voltage	Relay type	Socket type (reference with the 39 Series)				
		Master <b>BASIC</b> (39.10.....)	Master <b>PLUS</b> (39.30.....)	Master <b>INPUT</b> (39.40.....)	Master <b>OUTPUT</b> (39.20.....)	Master <b>TIMER</b> (39.80.....)
12 V AC/DC	34.81.7.012.xxxx	—	—	—	—	93.68.0.024
24 V AC/DC	34.81.7.024.xxxx	—	93.63.0.024	93.64.0.024	—	93.68.0.024
(110...125)V AC/DC*	34.81.7.060.xxxx	—	93.63.3.125	—	—	—
(220...240)V AC*	34.81.7.060.xxxx	—	93.63.3.230	—	—	—
(110...125)V AC/DC	34.81.7.060.xxxx	93.61.0.125	93.63.0.125	93.64.0.125	93.62.0.125	—
(24...240)V AC/DC	34.81.7.024.xxxx	—	93.63.0.240	—	—	—
(220...240)V AC	34.81.7.060.xxxx	93.61.8.230	93.63.8.230	93.64.8.230	93.62.8.230	—
6 V DC	34.81.7.005.xxxx	93.61.7.024	93.63.7.024	93.64.7.024	93.62.7.024	—
12 V DC	34.81.7.012.xxxx	93.61.7.024	93.63.7.024	93.64.7.024	93.62.7.024	—
24 V DC	34.81.7.024.xxxx	93.61.7.024	93.63.7.024	93.64.7.024	93.62.7.024	—
60 V DC	34.81.7.060.xxxx	—	93.63.7.060	—	—	—
(110...125)V DC	34.81.7.060.xxxx	—	93.63.7.125	—	—	—
220 V DC	34.81.7.060.xxxx	—	93.63.7.220	—	—	—

\* Leakage current suppression

Approvals  
(according to type):**Accessories**

16-way jumper link	093.16 (blue), 093.16.0 (black), 093.16.1 (red)
Dual-purpose plastic separator	093.60
Sheet of marker tags	060.72

**Technical data**

Rated values	6 A - 250 V
Dielectric strength	6 kV (1.2/50 μs) between coil and contacts
Protection category	IP 20
Ambient temperature	°C -40...+70
Screw torque	Nm 0.5
Wire strip length	mm 10
Max wire size	Solid wire and stranded wire
	mm <sup>2</sup> 1 x (0.2...2.5) / 2 x 1.5
	AWG 1 x (24...14) / 2 x 16

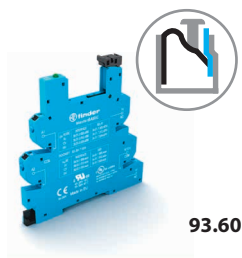

**Push-In terminal socket** 35 mm rail mounting (EN 60715) NEW

**Common features**

- Space saving 6.2 mm wide
- Connections for 16-way jumper link
- Terminal doubler 093.62
- Integral coil indication and protection circuit
- Secure retention and easy ejection by plastic clip

For technical data and supply versions, refer to the Master**INTERFACE 39 Series** – “Relay interface module”

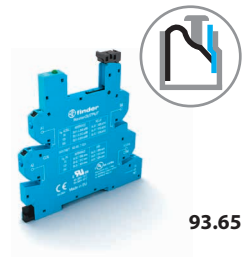

**Electromechanical Relay - EMR**

Supply voltage	Relay type	Socket type (reference with the 39 Series)				
		Master <b>BASIC</b> (39.01.....)	Master <b>PLUS</b> (39.61.....)	Master <b>INPUT</b> (39.71.....)	Master <b>OUTPUT</b> (39.51.....)	Master <b>TIMER</b> (39.91.....)
6 V AC/DC	34.51.7.005.xx10	93.60.7.024	93.66.7.024	93.67.7.024	93.65.7.024	—
12 V AC/DC	34.51.7.012.xx10	93.60.7.024	93.66.7.024	93.67.7.024	93.65.7.024	93.69.0.024
24 V AC/DC	34.51.7.024.xx10	93.60.7.024	93.66.7.024	93.67.7.024	93.65.7.024	93.69.0.024
60 V AC/DC	34.51.7.060.xx10	—	93.66.7.060	—	—	—
110...125)V AC/DC*	34.51.7.060.xx10	—	93.66.3.125	—	—	—
(220...240)V AC*	34.51.7.060.xx10	—	93.66.3.230	—	—	—
110...125)V AC/DC	34.51.7.060.xx10	93.60.0.125	93.66.0.125	93.67.0.125	93.65.0.125	—
24...240)V AC/DC	34.51.7.024.xx10	—	93.66.0.240	—	—	—
(220...240)V AC	34.51.7.060.xx10	93.60.8.230	93.66.8.230	93.67.8.230	93.65.8.230	—
(110...125)V DC	34.51.7.060.xx10	—	93.66.7.125	—	—	—
220 V DC	34.51.7.060.xx10	—	93.66.7.220	—	—	—

\* Leakage current suppression



**Solid State Relay - SSR**

Supply voltage	Relay type	Socket type (reference with the 39 Series)				
		Master <b>BASIC</b> (39.00.....)	Master <b>PLUS</b> (39.60.....)	Master <b>INPUT</b> (39.70.....)	Master <b>OUTPUT</b> (39.50.....)	Master <b>TIMER</b> (39.90.....)
12 V AC/DC	34.81.7.012.xxxx	—	—	—	—	93.69.0.024
24 V AC/DC	34.81.7.024.xxxx	—	93.66.0.024	93.67.0.024	—	93.69.0.024
110...125)V AC/DC*	34.81.7.060.xxxx	—	93.66.3.125	—	—	—
(220...240)V AC*	34.81.7.060.xxxx	—	93.66.3.230	—	—	—
110...125)V AC/DC	34.81.7.060.xxxx	93.60.0.125	93.66.0.125	93.67.0.125	93.65.0.125	—
24...240)V AC/DC	34.81.7.024.xxxx	—	93.66.0.240	—	—	—
(220...240)V AC	34.81.7.060.xxxx	93.60.8.230	93.66.8.230	93.67.8.230	93.65.8.230	—
6 V DC	34.81.7.005.xxxx	93.60.7.024	93.66.7.024	93.67.7.024	93.65.7.024	—
12 V DC	34.81.7.012.xxxx	93.60.7.024	93.66.7.024	93.67.7.024	93.65.7.024	—
24 V DC	34.81.7.024.xxxx	93.60.7.024	93.66.7.024	93.67.7.024	93.65.7.024	—
60 V DC	34.81.7.060.xxxx	—	93.66.7.060	—	—	—
(110...125)V DC	34.81.7.060.xxxx	—	93.66.7.125	—	—	—
220 V DC	34.81.7.060.xxxx	—	93.66.7.220	—	—	—

\* Leakage current suppression

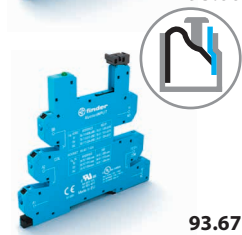

Approvals  
(according to type):



**Accessories**

16-way jumper link	093.16 (blue), 093.16.0 (black), 093.16.1 (red)
Dual-purpose plastic separator	093.60
Terminal doubler	093.62
Sheet of marker tags	060.72

**Technical data**

Rated values	6 A - 250 V
Dielectric strength	6 kV (1.2/50 μs) between coil and contacts
Protection category	IP 20
Ambient temperature	°C -40...+70
Wire strip length	mm 8
Max wire size	Solid wire and stranded wire
	mm <sup>2</sup> 1 x(0.2...2.5)
	AWG 1 x(24...14)

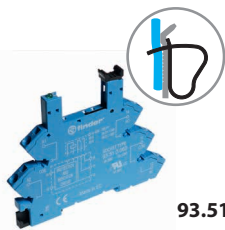

A



93.51

**Screw less terminal socket 35 mm rail mounting (EN 60715)****Common features**

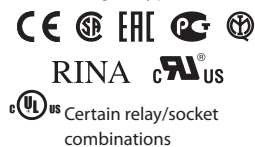
- Space saving 6.2 mm wide
- Connections for 20-way jumper link
- Integral coil indication and protection circuit
- Secure retention and easy ejection by plastic clip

For technical data and supply versions, refer to the **38 Series** – “Relay interface module”Approvals  
(according to type):RINA cRU<sup>®</sup> US
 Certain relay/socket combinations
**Electromechanical Relay - EMR and Solid State Relay - SSR**

Supply voltage	Relay type (reference with the 38 Series)		Socket type
	Electromechanical relay - EMR (38.61.....)	Solid State Relay - SSR (38.81.....)	
12 V AC/DC	34.51.7.012.xx10	—	93.51.0.024
24 V AC/DC	34.51.7.024.xx10	—	93.51.0.024
110...125)V AC/DC	34.51.7.060.xx10	34.81.7.060.xxxx	93.51.0.125
220...240)V AC/DC	34.51.7.060.xx10	34.81.7.060.xxxx	93.51.0.240
110...125)V AC/DC*	34.51.7.060.xx10	34.81.7.060.xxxx	93.51.3.125
(220...240)V AC*	34.51.7.060.xx10	34.81.7.060.xxxx	93.51.3.240
(220...240)V AC	34.51.7.060.xx10	34.81.7.060.xxxx	93.51.8.240
12 V DC	34.51.7.012.xx10	34.81.7.012.xxxx	93.51.7.024
24 V DC	34.51.7.024.xx10	34.81.7.024.xxxx	93.51.7.024
60 V DC	34.51.7.060.xx10	34.81.7.060.xxxx	93.51.7.060

\* Leakage current suppression

**Accessories**

20-way jumper link	093.20
Plastic separator	093.01
Sheet of marker tags	093.64

**Technical data**

Rated values	6 A - 250 V
Dielectric strength	6 kV (1.2/50 μs) between coil and contacts
Protection category	IP 20
Ambient temperature ( $U_N \leq 60$ V / $> 60$ V)	°C -40...+70 / -40...+55
Wire strip length	mm 10
Max wire size	Solid wire and stranded wire
	mm <sup>2</sup> 1 x 2.5 / 2 x 1.5
	AWG 1 x 14 / 2 x 16





**93.11**

Approvals  
(according to type):



<b>PCB socket with retaining and release clip</b>	<b>93.11 (blue)</b>
For relay type	34.51, 34.81
<b>Technical data</b>	
Rated values	6 A - 250 V
Dielectric strength	≥ 6 kV (1.2/50 μs) between coil and contacts
Protection category	IP 20
Ambient temperature	°C -40...+70

**A**

**Retaining and release clip use:**

